

Varion[®] Hoist

You told us what you needed, and we listened: with batten lengths up to 45' (13.7 m) and as much as 50' (15.2 m) of travel, the Varion hoist delivers a gross lifting capacity of 1,500 lb (680 kg). Five lift lines feature steel guides, so there's no danger of cables crossing the groove. The hoist can be supported from the top of the beam or underhung – whatever works best for your needs in your theatre. Equally important, this affordable hoist gives you the flexibility you need at a price point your budget can handle.

Applications

- Front of house and stage

Features

- Travel: up to 50' (15.2 m)
- Batten length: up to 45' (13.7 m)
- Speed: 15 fpm
- Live load: 1,350 lb (612 kg) without plug-in strip;
1,000 lb (454 kg) with plug-in strip
- Lift lines: five; adjustable on back bone
- Wire rope diameter: 3/16" (5 mm)
- Three-year warranty against defects in materials or workmanship is provided on all J.R. Clancy equipment, additional warranty information is available at jrclancy.com

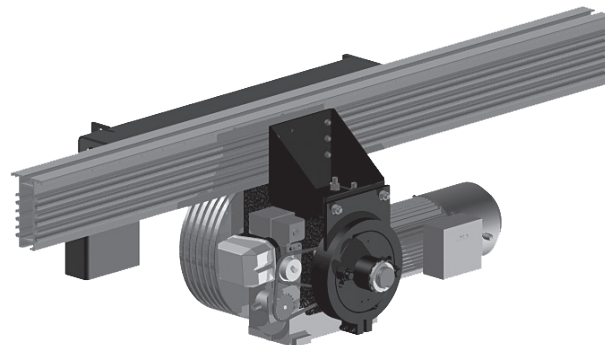

Options include

- Encoder
- Cable management: flat fold
- Light circuits: up to 36 (configuration dependent)
- Cable management system
- Data available for DMX or Ethernet protocol

Safety

- Hoist overload detection
- Overspeed brake
- Robust back bone to eliminate horizontal forces on the building

Control Options

- The Varion hoist works with the entire range of J.R. Clancy motion control systems.

Mounting

It can be underhung or sit on top of grid.

Motor Information

Volts	Phase	Hz	Amperage
208V	3-phase	60 Hz	4.9 FLA*
460V	3-phase	60 Hz	2.2 FLA*
380-415V	3-phase	50/60 Hz	2.53 FLA*

*FLA = Full Load Amperage

Dimensions

- 46.25" w x 20.5" d x 21" h (1175 mm x 521 mm x 533 mm)

Weight

- Less than 500 lb (226.8 kg)

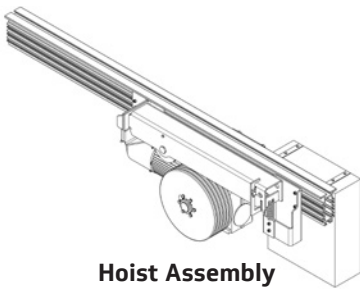

Hoist Assembly

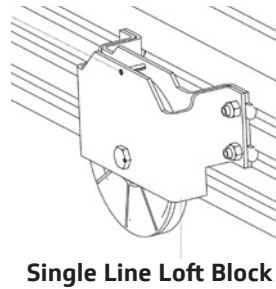

Single Line Loft Block

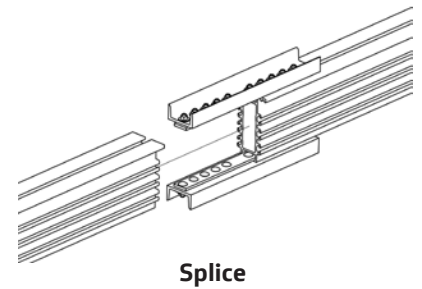

Splice

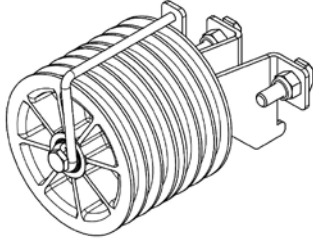

Idler Assembly

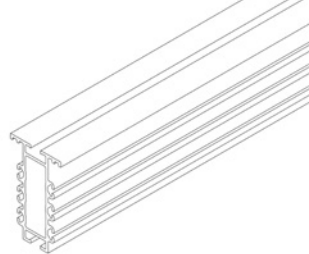

Back Bone (Beam)

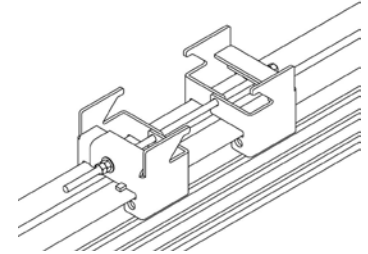

Beam Clamp

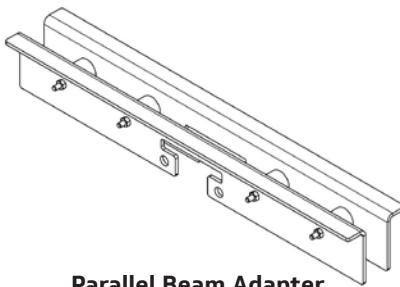

Parallel Beam Adapter

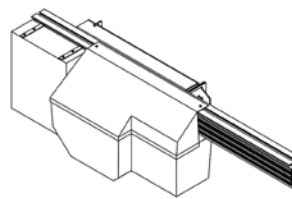

Optional Cover (View 1)

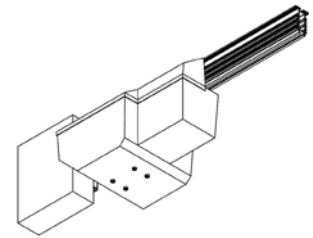

Optional Cover (View 2)

Order Information

Number	Description
018-1718	Varion Hoist 1,500 lb, 15 fpm
Varion Hoist Motor Assembly Configurations	
018-1718-2-FE	Varion Hoist 208V, beam mounted SceneControl starter with encoder
018-1718-2-J	Varion Hoist 208V, beam mounted junction box
018-1718-2-JE	Varion Hoist 208V, beam mounted junction box with encoder
018-1718-2-P	Varion Hoist 208V, beam mounted pushbutton starter
018-1718-4-FE	Varion Hoist 480V, beam mounted SceneControl starter with encoder
018-1718-4-J	Varion Hoist 480V, beam mounted junction box
018-1718-4-JE	Varion Hoist 480V, beam mounted junction box with encoder
018-1718-4-P	Varion Hoist 480V, beam mounted pushbutton starter
Varion Hoist Accessories	
088-1766	Back Bone (Beam) 20' Section
118-1729	Idler Assembly
118-1732	Single Line Loft Block
118-1762	Beam Clamp
118-1790	Splice
118-1795	Parallel Beam Adapter

Varion Riser — Typical

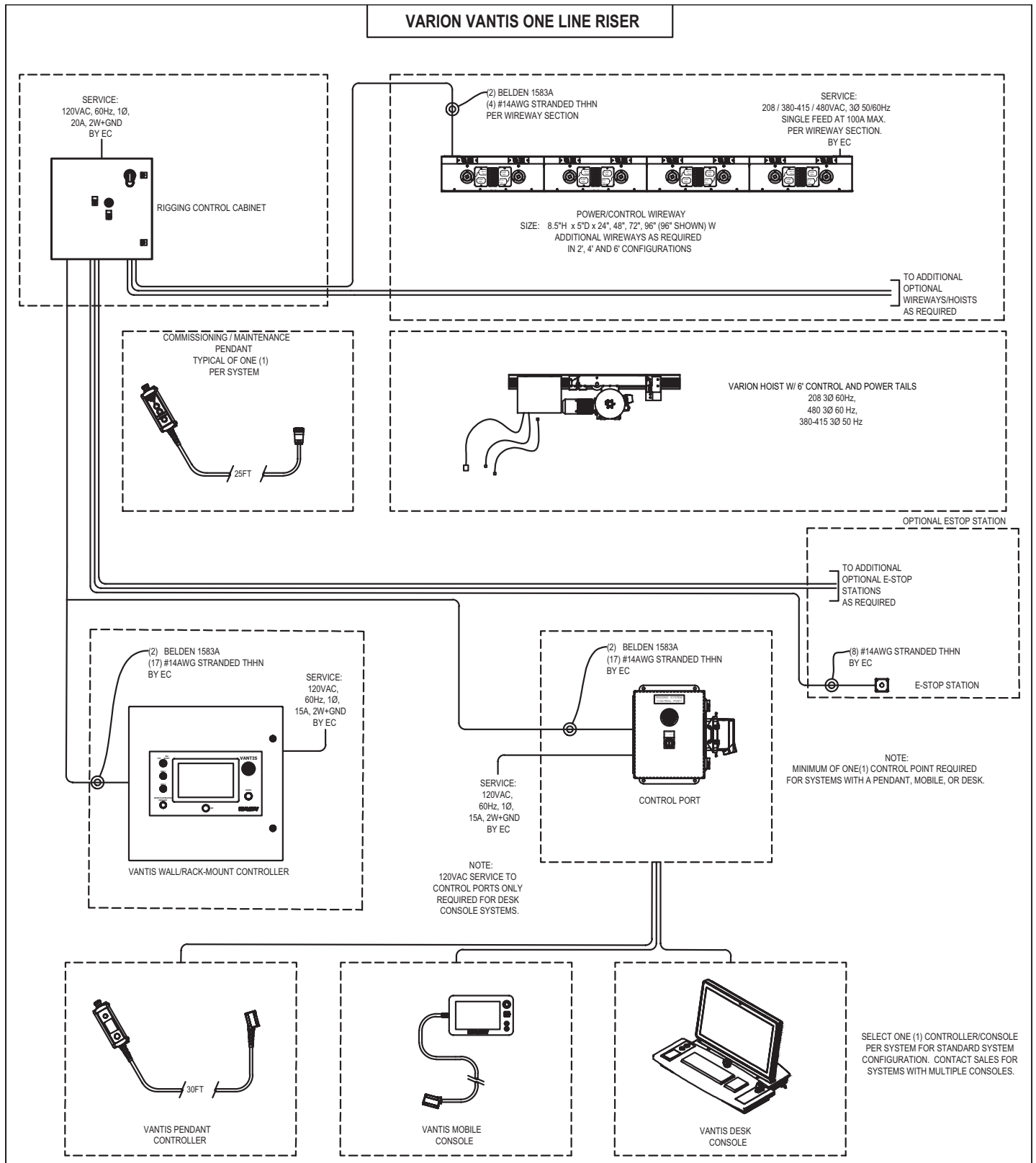

© 2024 Wenger Corporation
USA/2024-05

Minnesota Location

Wenger Phone 800.4WENGER (493-6437) Wenger Worldwide +1.507.455.4100 | Parts & Service 800.887.7145 | wengercorp.com
GearBoss Phone 800.493.6437 | gearboss.com
555 Park Drive, PO Box 448 | Owatonna | MN 55060

New York Location

J.R. Clancy Phone 800.836.1885 JR Clancy Worldwide +1.315.451.3440 | jrclancy.com | 7041 Interstate Island Road | Syracuse | NY 13209